

PROTEUS

A stylized, light gray profile of a man's head, likely Proteus, facing right. The profile is composed of several overlapping, wavy, brush-stroke-like lines that create a sense of movement and texture. The head is positioned behind the word 'PROTEUS' and extends across the top right of the page.

IMAC

Proteus IMAC Handbook

Mini & Midi spin columns

SECTION 1

Introduction	2
Proteus benefits	3
Contents of a Proteus spin column kit	4
Additional equipment recommended	8
Storage conditions	8
Technical support	9
Specifications	10

SECTION 2

Principles of Metal Chelate chromatography	11
Affinity chromatography	12
General conditions for optimal binding	16
Choosing the correct buffer conditions	18
Eluting the protein from a Proteus spin column	19
Binding kinetics of Proteus metal chelate spin columns	20
Proteus metal chelate affinity resin	21

SECTION 3

Easy-to-read protocol for purifying recombinant proteins using IMAC	22
Procedure to prepare working solutions of the Metal Chelate buffers	23
Step by step Mini Protocol	26
Step by step Midi Protocol	30
Selected Metal Chelate applications under native and denaturing conditions.	34

APPENDIX

Procedure to convert RPM to RCF in a fixed angle rotor	39
Procedure to convert RPM to RCF in a swing bucket rotor	40
Metal Chelate kit buffer formulations	41
Questions and answers	42
Troubleshooting assistant	47
Glossary	50
References	53
Ordering information	54

Introduction:

The Proteus IMAC kit is designed for simple, rapid His-tagged recombinant protein purification from a cell lysate under native or denaturing conditions. Proteus spin columns replace lengthy and expensive chromatographic methods such as FPLC®. Metal chelate affinity chromatography is a rapid one-step purification, which removes most contaminants and can achieve purities close to homogeneity.

This Proteus IMAC purification kit incorporates pre-packed Ni²⁺-IDA agarose resin plugs in ready-to-use spin columns. The objective is to offer the researcher total protein purification solutions from the initial fractionation stage to the final polishing steps. Resolution of the His-tagged protein is achieved either in a 2.2 ml microfuge tube for the Proteus Mini spin column or in a 50 ml centrifuge tube for the Proteus Midi spin column.

The rapid purification protocols provided in this handbook for affinity chromatography permit the recovery of high levels of pure recombinant protein in minutes. Large numbers of samples can be processed at the same time. There is negligible hold-up volume; ensuring high solute recovery with minimal non-specific absorptive losses. Proteus employs powerful resin-based technology for separating proteins and involves only a few steps, making the isolation of pure protein samples rapid and simple to perform. Recombinant proteins purified using Proteus spin columns may be used in a wide range of structure and activity-based laboratory procedures.

FPLC® is a registered trademark of Amersham Biosciences



Proteus Benefits:

- Proteus IMAC kits are designed to eliminate tedious chromatographic steps normally associated with metal chelate chromatography.
- Proteus IMAC technology reduces time-to-purity by incorporating protocols to suit various applications, supported by a comprehensive handbook and required buffers in a convenient kit format.
- The beaded supports offer excellent flow properties. This combined with the tapering of the Midi spin column provides uniform flow paths that allow optimal use of the available resin bed in swing bucket rotors. The Mini spin columns are specifically designed for fixed angle rotors found in all microfuges.

- Negligible hold-up volume of the IMAC resin plug ensures high recovery of the recombinant protein of interest.
- The provision of a disposable spin column is ideally suited to GMP production where current user requirements and price sensitivities demand regeneration of the affinity matrix using harsh treatments.

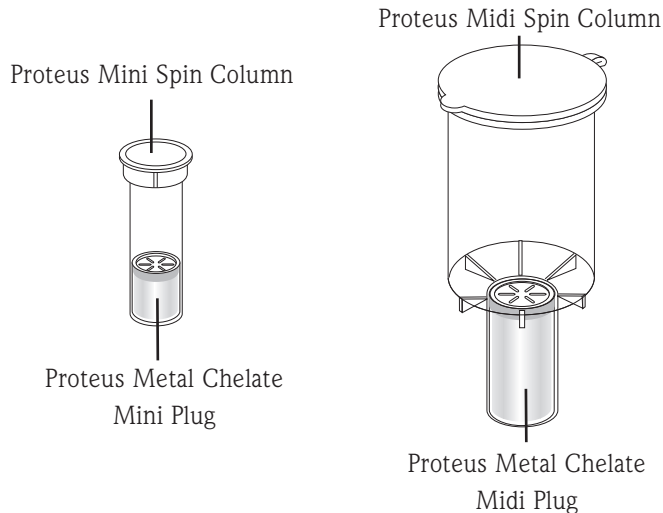

Proteus IMAC Mini spin column kit contents:

The Proteus Mini kit contains:

- 24 x Proteus spin column plugs containing Ni-IDA agarose resin.
- 24 x Proteus spin columns (0.65 ml capacity in a fixed angle rotor).
- 48 x 2.2 ml centrifuge tubes.
- 24 x 10 kDa MWCO ultrafiltration spinners.
- 1 x 250 ml 5 x PBS buffer (buffer A) bottle.
- 1 x 150 ml 1 x imidazole buffer (buffer B) bottle.
- Plug insertion tool.
- Comprehensive handbook.
- Ultrafiltration spinner instruction sheet.
- Laminated protocol card.

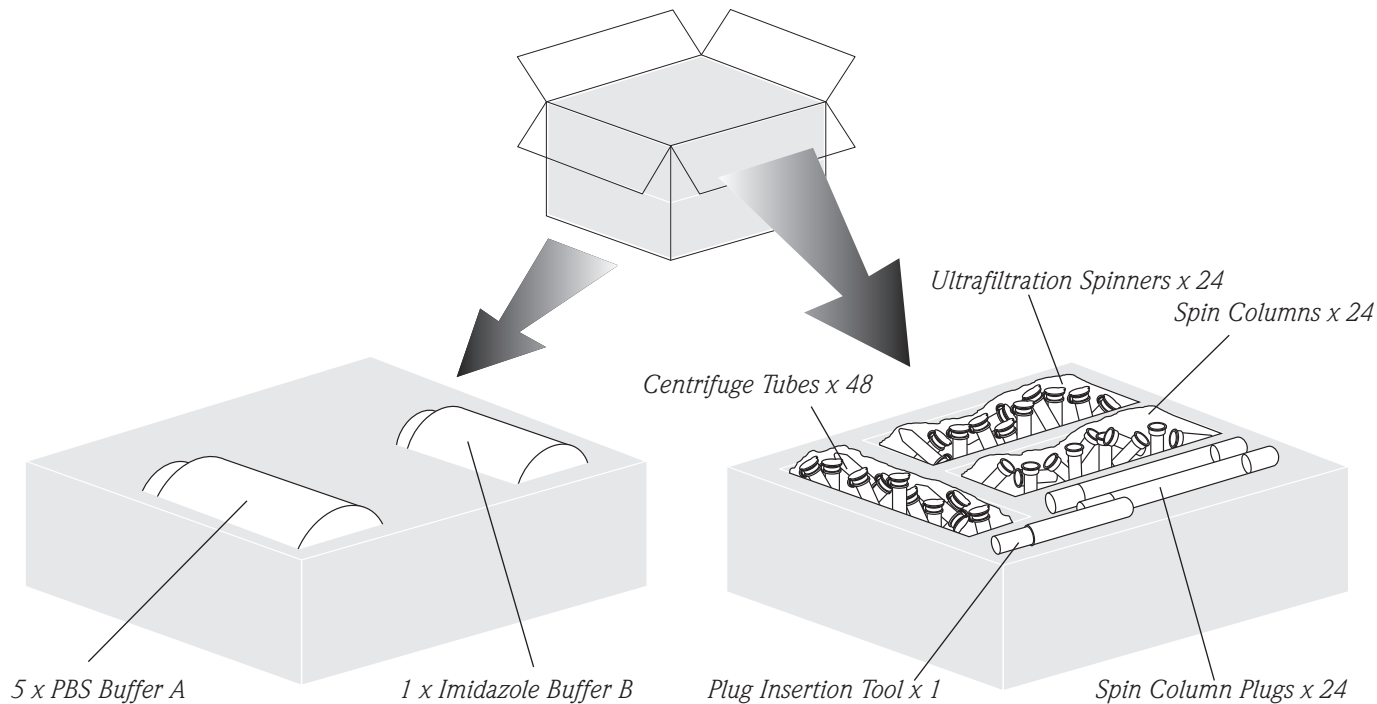
Proteus IMAC Mini spin column kit contents:

Proteus IMAC Midi spin column kit contents:

The Proteus Midi kit contains:

- 8 x Proteus spin column plugs containing Ni-IDA agarose resin.
- 8 x Proteus spin columns (20 ml capacity in a swing bucket rotor).
- 12 x 50 ml centrifuge tubes.
- 8 x 10 kDa MWCO ultrafiltration spinners.
- 1 x 250 ml 5 x PBS buffer (buffer A) bottle.
- 1 x 150 ml 1 x imidazole buffer (buffer B) bottle.
- Plug insertion tool.
- Comprehensive handbook.
- Ultrafiltration spinner instruction sheet.
- Laminated protocol card.

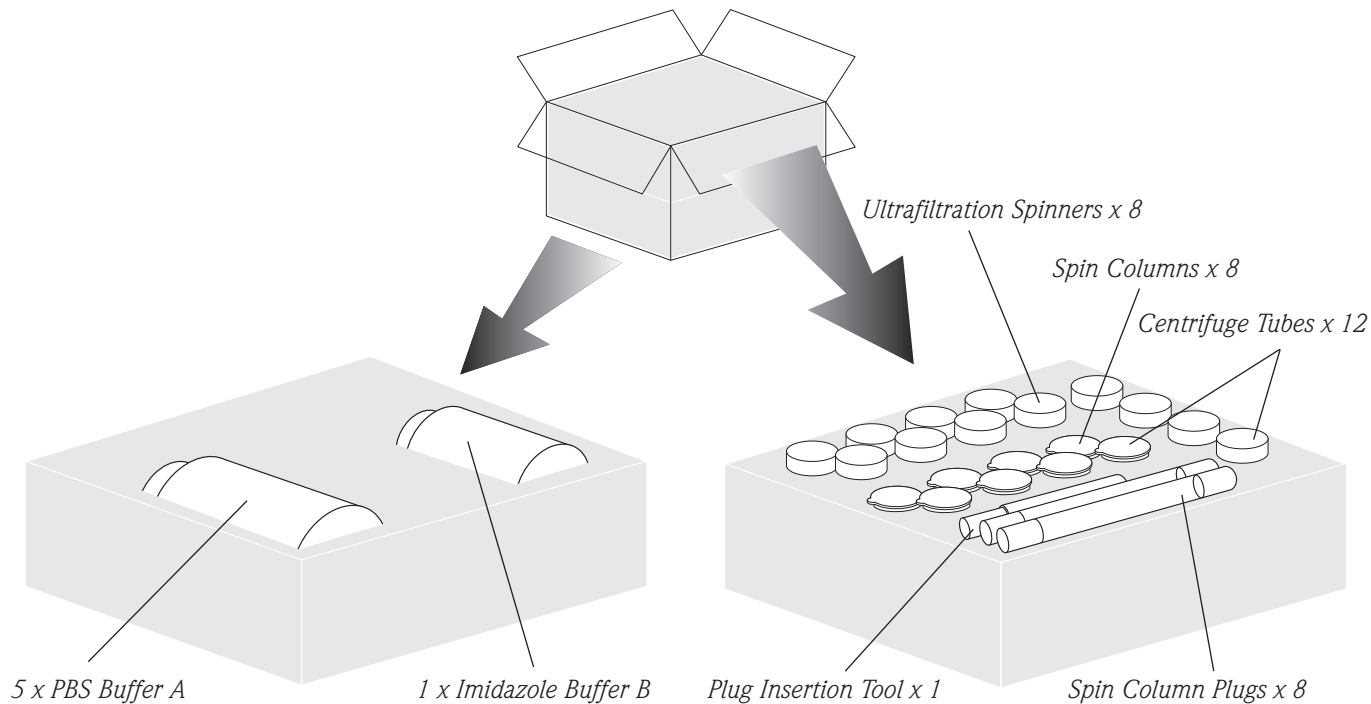
Proteus IMAC Midi spin column kit contents:

Additional equipment recommended:

- Syringe-end filters: 0.2 μm and 1.2 μm for clarification.
- Quartz cuvettes for UV absorbance measurements.
- UV/VIS spectrophotometer.
- Pasteur pipettes and micro-pipettes.
- Marker pen and test tube rack.
- A bench-top centrifuge with swing bucket rotor that can accommodate 50 ml centrifuge tubes.
- A microfuge that can accommodate 2.2 ml microcentrifuge tubes.

*N.B. (For the Midi spin column only) The preferred rotor is a **swing bucket** rotor. For optimal performance with a fixed angle rotor, ensure that the orientation of the spin column in the rotor is the same for sample binding, washing and elution steps.*

Storage conditions:

Remove the Proteus IMAC plug box from the kit and store it at 2-8 °C. There is no need to place the rest of the kit in a fridge or cold room. All buffers, for example, contain 0.1 % sodium azide and can be stored at room temperature. Do not freeze the resin plugs or store them at room temperature. Freezing the suspension will damage the agarose beads. The resin is pre-swollen and de-fined. It is transported in 20 % ethanol. Proteus spin columns are stable for up to 2 years at 2-8 °C from the date of manufacture. The expiry date is recorded clearly on the outside of the box.

Disclaimer:

This product is for research use only and is not intended for use in clinical diagnosis. No claims beyond replacement of unacceptable material or refund of purchase price shall be allowed.



Technical support:

Contact the Protein Ark technical support and sales centre for assistance:

Protein Ark Ltd
The Innovation Centre,
217 Portobello,
Sheffield
S1 4DP, UK

Tel: +44 (0) 33 33 40 20 25

Fax: +44 (0) 33 33 40 20 25

Email: info@proteinark.com

Web: www.proteinark.com

Specifications:

Supporting Proteus matrix: Covalently coupled to agarose resin

Charged metal ion: Ni²⁺

Max sample volume: 0.65 ml (Mini, Fixed angle rotor)
20 ml (Midi, Swing bucket rotor)

Resin bed volume: 0.23 ml (Mini)
1.6 ml (Midi)

Bead size range: 45-165 μ m

Recommended working pH: pH 2.0-12.0

Typical number of uses per plugs: 2 (Mini)
2 (Midi)

Typical binding capacity: 1 mg His-tagged recombinant protein (Mini)
10 mg His-tagged recombinant protein (Midi)

Chemical stability: High

Endotoxin levels: Unknown

Solubility in water: Insoluble

Plastic construction: Polypropylene

Colour coded end-caps: Black

Chemical compatibility of the Proteus spin columns:

All resins are susceptible to oxidative agents. Avoid high temperatures. The spin columns are resistant to short exposure to organic solvents (e.g. 30 % ethanol) and are stable in all aqueous buffers commonly used for metal chelate chromatography cleaning-in-place e.g. 1 M NaOH, 0.01 M HCl. IMAC resin is resistant to 6 M guanidine-HCl and 8 M urea.

Principles of Metal Chelate chromatography:

This handbook focuses specifically on metal chelate affinity chromatography. Proteins are engineered with affinity tags attached to the 5' or 3' end of the target gene. Examples of such tags are hexahistidine (M_r 700-900) and an 8-residue peptide containing alternating histidines (M_r 900).

IMAC technology was introduced by Porath et al (1975). The matrix is attached to chelating groups that immobilize

transition metal ions such as Ni^{2+} , Co^{2+} , Cu^{2+} , Zn^{2+} (see Porath and Olin, 1983; Porath, 1988; Sulkowski, 1989). Certain amino acids such as histidine, tryptophan, cysteine and tyrosine can act as electron donors on the surface of the protein and bind reversibly to the transition metal ion. In the vast majority of instances, 6 x histidine tag is engineered at the N or C terminus of the protein ($K_d - 10^{-13}$ at pH 8.0).

The most common matrix for IMAC purification is iminodiacetic acid (IDA). Ni^{2+} is the most widely used metal ion as most IMAC tags seem to have very high affinity for immobilized Ni^{2+} . The simplicity of IMAC technology is extremely attractive as it lends itself to the bind, wash and elute mode of operation if the appropriate buffer formulations are selected. IMAC can often be used with samples without any pre-treatment e.g. buffer exchange step. The use of metal chelate affinity is widespread for the selective adsorption of engineered recombinant proteins and has largely superseded non-affinity methods of chromatography for purifying recombinant proteins.

Application drivers for Metal Chelate chromatography:

Multiple parallel purifications of His-tagged engineered recombinant proteins

Screening expression clones for high levels of His-tagged proteins

Scouting mutant clones for recombinant protein expression

Purification of recombinant proteins for raising antibodies

Purification of recombinant proteins for activity and/or structural studies

Affinity chromatography:

The essence of affinity chromatography utilizes the concept of bio-specificity, implying an interaction between a natural binding site and the natural ligand, whether it be enzyme-substrate, enzyme-inhibitor or His-tagged protein-metal ion interactions.

Often a researcher needs to choose the correct base matrix, select the optimal activation chemistry and couple a suitable ligand to develop an affinity column to purify the target protein. Proteus spin columns remove the guesswork associated with optimizing the resin chemistry by offering ready-to-use resin plugs that have satisfied stringent quality control to guarantee reproducible purification performance. Many affinity support preparations require less than 5 ml resin so these Mini and Midi spin columns contain ideal bed volumes. Optimal buffer and elution conditions for the purification step of many His-tagged proteins have been defined and these are recommended on page 23.

Most columns currently offered operate by gravity flow and typically contain less than 5 ml resin. The columns are normally constructed from polystyrene or polypropylene with a simple barrel and the addition of porous disks to contain the resin. However, the affinity separation often takes several hours to complete; in addition the researcher usually has to pack the column, which can add a minimum 2 further hours to the purification step. The elaborate nature of the packing means that it is usually undertaken by an experienced laboratory worker.

The majority of purifications require fast processing times to minimise the hydrolytic actions of proteases. Proteus IMAC kits allow multiple parallel purifications to be achieved without the need to employ expensive PEEK tubing (protein-friendly)-based chromatography systems. For example, 12 parallel small scale His-tagged protein purifications can be achieved in a microfuge containing a 12 tube fixed angle rotor.

Fig. 1. Schematic diagram of a Proteus Mini or Midi IMAC spin column plug.

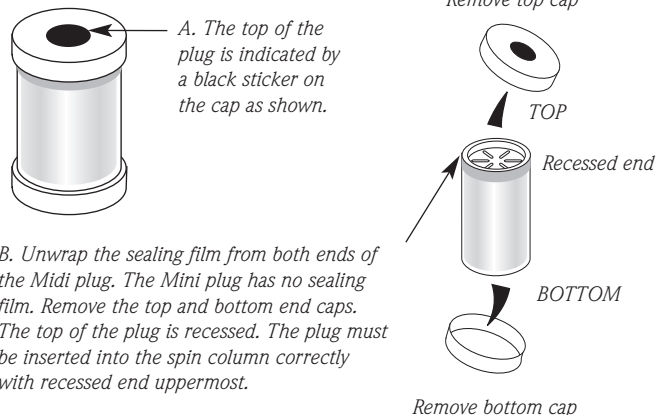

The plug and play concept for the Proteus Mini spin column

Loading the plug into the spin column

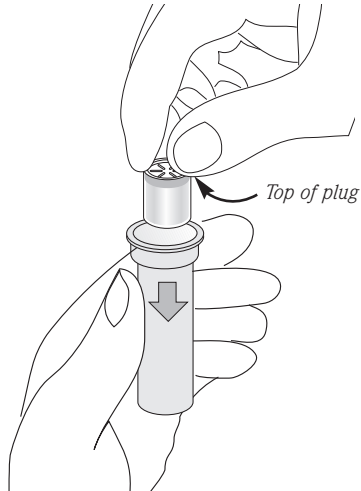

Place the plug into the spin column with the recessed end uppermost.

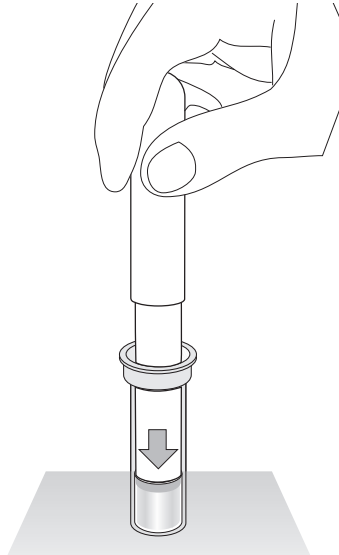

*Push the plug **FULLY** into the tapered end of the spin column using the plug insertion tool.*

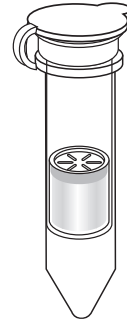

It is now ready for pre-equilibration with binding buffer followed by centrifugation.

The plug and play concept for the Proteus Midi spin column

Loading the plug into the spin column

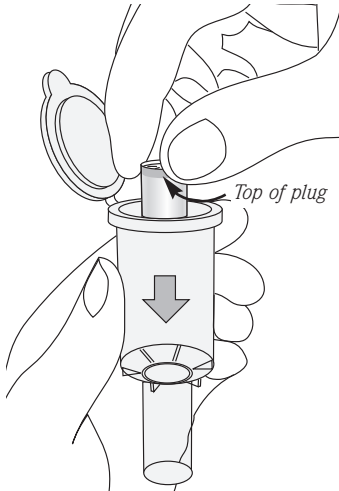

Place the plug into the spin column with the recessed end uppermost.

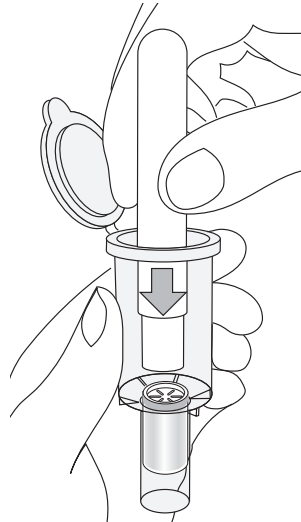

*Push the plug **FULLY** into the tapered end of the spin column using the plug insertion tool.*

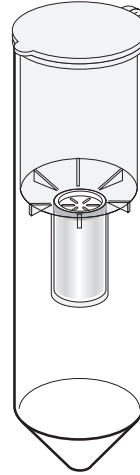

It is now ready for pre-equilibration with binding buffer followed by centrifugation.

Removing the plug from the spin column

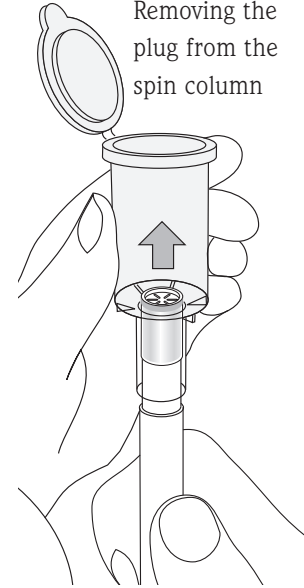

After use, the plug is removed using the plug insertion tool.

General considerations for selecting optimal binding conditions for Proteus IMAC kits.

This kit exploits the hexahistidine sequence that permits efficient purification of the expressed protein from a broad host such as bacterial cells, Baculovirus vectors, mammalian cells or yeast. Baculovirus, mammalian cells and yeast expression vectors are often used to express eukaryotic proteins as they generate proteins with the similar post-translational modifications such as phosphorylations and glycosylations.

Lysis conditions, such as the nature of the lysis buffer, depend upon the type of expression vector. Mammalian or Baculovirus-infected insect cells can be lysed by sonication at +4 °C with either freeze/thaw cycles or addition of up to 1 % non-ionic detergents and cell lysis of *E.coli* is usually achieved by sonication on ice or homogenization either with or without lysozyme treatment.

The culture pellet is resuspended in lysis buffer at a pH close to pH 7.4-8.0 using a similar concentration of buffer, imidazole and NaCl to that of a pre-equilibration buffer used for metal chelate chromatography. Binding of His-tagged soluble proteins present in the cytoplasm or periplasm and insoluble aggregates in the presence of denaturants occurs close to physiological pH.

Typically, a protease inhibitor cocktail, such as Boehringer "Complete EDTA-free", 5-50 $\mu\text{g/ml}$ DNase I and 10 mM β -mercaptoethanol are added to the lysis buffer. Addition of β -mercaptoethanol to the lysis buffer and the binding, wash and elution buffers are optional. Its inclusion depends upon whether the His-tagged protein elutes with contaminants as β -mercaptoethanol can reduce all disulphide bonds formed between the contaminating proteins and the target protein. Initially, the researcher should try to bind the His-tagged protein directly from the cleared lysate.



It is imperative that the lysate is completely clear as any particulate matter e.g. cell debris will partially foul the resin and cause spin times for the binding, washing and elution steps to be increased. It is important that the sample is first filtered through a 0.2 μm syringe-end filter to remove particulates that could clog the resin flow channels. All samples should be filtered just prior to loading even if they have been filtered several days before the chromatographic run.

If the binding efficiency is poor and the lysis buffer differs significantly from the pre-equilibration buffer, optimal binding of the His-tagged protein to the Ni-IDA spin columns can be achieved by rapid dialysis, diafiltration using ultrafiltration concentrators, gel-filtration chromatography in the appropriate pre-equilibration buffer or titration with a concentrated stock solution of pre-equilibration buffer.

Note that the precise conditions for binding, washing and eluting your target protein may need to be optimized empirically as there are several factors such as accessibility of the His-tag which affect protein behaviour in non-denaturing conditions during metal chelate chromatography.

Aggregation/precipitation of proteins is common during storage and repeated freeze/thaw cycles. Of equal importance is the ability to process the samples rapidly and, if the need arises, to be able to purify the target protein in a Proteus spin column at 4 °C.

Optimal conditions for binding the target molecule to a resin are critical for successful separation of the protein. If the binding conditions are not optimal with respect to pH, salt concentration, presence of metal ions or chelating agents, flow rates, residence time etc, purification is adversely affected.

Choosing the correct buffer conditions for IMAC separations:

We recommend sodium phosphate buffers as buffers with secondary or tertiary amines e.g. Tris buffers can reduce the nickel ion. pH 7-8 works well for most immobilized Ni²⁺ applications and 0.15-0.5 M NaCl is added to the buffers in order to prevent non-specific ionic interactions and to stabilize some proteins in solution.

Non-ionic detergents such as 8 M urea and 6 M guanidinium HCl do not interfere with metal chelate affinity separations. When a recombinant protein is expressed at high levels in *E.coli*, the protein elutes as insoluble aggregates called inclusion bodies. These denaturants completely unfold the target protein making the His-tag much more accessible for interaction with the immobilized Ni²⁺ matrix.

Attempts can be made to renature the target protein by dialyzing it sequentially against binding buffers containing decreasing levels of urea or passing decreasing levels of urea in binding buffer over the washed protein bound to the Ni-IDA spin column and eluting the refolded protein with 300 mM imidazole (between pH 7 and pH 8). Alternatively, denatured proteins can be diluted into a large volume of buffer lacking denaturant. The dispersive effect dilutes out the denaturant resulting in the re-folding of the protein.



Eluting the protein from a Proteus IMAC spin column:

The most common elution conditions for IMAC separations involve the use of a competitive counter-ligand such as imidazole. This is the preferred elution method for purifications under native conditions. For purifications under denaturing conditions, elution is performed either using imidazole in the presence of denaturant such as 8 M urea or by a reduction in elution pH from pH 7.4 to pH 4.5. It is important to appreciate that a few proteins are acid-labile and they can lose their activity at very low pH values. Above all, the elution conditions must preserve the integrity and activity of the target protein. Most observed denaturation is caused by harsh elution conditions.

Binding kinetics of IMAC spin columns

The flow rate through an affinity chromatography support is important in achieving optimal separation. Flow rate through the column support is inextricably related to the efficiency of the separation; too fast a flow will cause the mobile phase to move past the beads faster than the diffusion time necessary to reach the internal bead volume. Our studies demonstrate that the large internal surface area of the Midi Proteus resin bed compensates completely for the velocity of the mobile phase through the column support when the centrifugal speed does not exceed 1,250 g*.

The IMAC resin chemistries used in the Proteus spin column have sufficiently rapid association kinetics between the protein molecule and the immobilized ligand to allow for optimal diffusional flow through the internal bead structure. The spin speed is set slower than the other steps in the bind-wash-elute protocol as a lower residence time between the affinity support and the target protein will generate a lower binding capacity (Cuatrecasas et al, 1968). The slower sample loading spin speeds (100-150 g) of 30 min ensures that the affinity supports operate close to their optimal binding configuration.

Traditionally, gravity flow chromatography is very slow and resolution of the protein separation can be adversely affected by secondary diffusion effects.

*No Midi performance data is available for spin speeds greater than 1,250 g.



Ni-IDA affinity resin:

IDA cross-linked agarose resin consists of iminodiacetic acid groups ligated by stable ether linkages via a flexible spacer arm. The resin is charged with Ni^{2+} to give a marine blue appearance. The resultant Ni^{2+} -IDA agarose matrix is ideal for the rapid purification of 6xHis-tagged proteins.

Protocol for purifying His-tagged proteins using Proteus IMAC kits:

Under NATIVE conditions:

These protocols refer to the purification of active folded proteins. As strength of binding will be determined by length and accessibility of the His-tag the metal ion, buffer composition and pH and elution conditions, some adjustments of the procedure in this handbook is often required.

Ideally, the cell lysate should be made up in phosphate buffer pH 7.4-8.0 in the presence of NaCl (to reduce non-specific adsorption effects).

The following metal chelate buffers are proposed for your IMAC separation. The procedure to prepare these working buffer solutions from stock buffers supplied in the kit is shown in Table 1 (page 23).

Suggested buffers for NATIVE IMAC purifications:

All buffers contain sodium azide as a preservative.

- Binding buffer:
50 mM sodium phosphate buffer pH 7.4,
300 mM NaCl, 10 mM imidazole.
- Wash buffer:
50 mM sodium phosphate buffer pH 7.4,
300 mM NaCl, 30 mM imidazole.
- Elution buffer:
50 mM sodium phosphate buffer pH 7.4,
300 mM NaCl, 300 mM imidazole.



Table 1 showing how to prepare your metal chelate binding, wash and elution buffers.

Imidazole concentration (mM)	Recommended usage	Buffer A (ml) (5 x PBS buffer)	Elution buffer B (ml) (1 M imidazole pH 7.4)	Distilled water (ml)	Total volume (ml)
10	Binding buffer	20	1	79	100
20		20	2	78	100
30		Wash buffer	20	3	77
50	20		5	75	100
100	20		10	70	100
150	20		15	65	100
200	20		20	60	100
250	20		25	55	100
300	Elution buffer	20	30	50	100
350		20	35	45	100
400		20	40	40	100
450		20	45	35	100
500		20	50	30	100

The two buffers provided in the kit are supplied as concentrated stocks. Always measure the pH of the working buffer solutions when they are prepared and adjust to pH 7.4 whenever necessary.

It is not uncommon for buffers to precipitate or freeze partially in the cold during long term storage or when laboratory temperatures drop at night. The buffers should be warmed up and they can be used once all the precipitate has re-dissolved.

Under DENATURING conditions:

Recombinant proteins often form insoluble inclusion bodies when they are expressed at high levels. These proteins can be solubilized easily in the presence of denaturants such as 6-8 M urea or 6 M guanidine hydrochloride. Additionally, a researcher may choose to purify their recombinant protein under denaturing conditions if they wish to use the purified denatured protein for raising antibodies. Two buffer configurations can be used under denaturing conditions. One buffer system employs imidazole to competitively elute the target protein under denaturing conditions and the other buffer system uses a more acidic pH to elute the target protein in the absence of imidazole. Choosing either buffer system on page 25 will depend critically upon the nature of your target protein e.g. stability in acid environment.

Suggested buffers for DENATURING purifications:**(1) Imidazole Elution:**

- Binding buffer:
50 mM sodium phosphate buffer pH 7.4,
300 mM NaCl, 10 mM imidazole, 6-8 M Urea.
- Wash buffer:
50 mM sodium phosphate buffer pH 7.4,
300 mM NaCl, 30 mM imidazole, 6-8 M Urea.
- Elution buffer:
50 mM sodium phosphate buffer pH 7.4,
300 mM NaCl, 300 mM imidazole, 6-8 M Urea.

(2) Acid Elution:

- Binding buffer:
50 mM sodium phosphate buffer pH 7.4,
300 mM NaCl, 6-8 M Urea.
- Wash buffer:
50 mM sodium phosphate buffer pH 6.0,
300 mM NaCl, 6-8 M Urea.
- Elution buffer:
50 mM sodium phosphate buffer pH 4.0,
300 mM NaCl, 6-8 M Urea.

N.B. Addition of urea will cause the pH to drop. Titrate the buffer with NaOH to bring the pH back to pH 7.4. The pH of those buffers containing urea should be checked and adjusted, if necessary, immediately before use.

Step by step protocol for Mini Spin Columns

RESIN PLUG LOADING

1. Load the pre-packed resin Mini plug containing immobilized IMAC resin into the Proteus spin column barrel using the Mini insertion tool as shown on page 14.

PRE-EQUILIBRATION (Total spin times = 2 mins)

2. Equilibrate the IMAC spin column with 0.65 ml binding buffer pH 7.4 (10 mM imidazole) by centrifuging the spin column at 1,800 g (4,400 rpm in a Heraeus Biofuge Pico or 5,000 rpm in a Sanyo MSE Micro Centaur) for 1 min. Repeat this pre-equilibration step with 0.65 ml binding buffer, pH 7.4 at 1,800 g for 1 min.

CLARIFICATION OF SAMPLE

3. Filter 1 ml sample through a 0.2 μm pore size syringe filter to remove any cellular debris, precipitating protein complexes just prior to sample loading.

SAMPLE LOADING (Total spin time = 6 mins)

4. Pipette up to 0.65 ml filtered cleared lysate into the spin column. Centrifuge the spin column at 640 g (2,600 rpm in a Heraeus Biofuge Pico or 3,000 rpm in a Sanyo MSE Micro Centaur) for 6 mins. It may be necessary to increase the spin time or spin speed if any sample remains above the plug.

N.B. In some circumstances, you may wish to re-apply the sample wash back through the spin column before the wash step in order to increase the residence time between the target protein and the resin plug for efficient binding.

* If 1 spin column is to be used, ensure that the spin column is counterbalanced in the microfuge with a microcentrifuge tube filled with the correct level of water.

WASHING (Total spin time = 5 mins)

5. Wash the spin columns up to five times with 0.65 ml wash buffer, pH 7.4 (30 mM imidazole) to remove non-tagged proteins with no affinity for the immobilized metal ion by centrifuging the spin columns for 1 min at 1,800 g (4,400 rpm in a Heraeus Biofuge Pico or 5,000 rpm in a Sanyo MSE Micro Centaur). The washes should be collected for analysis. As imidazole absorbs UV radiation at 280 nm, we recommend that the wash buffer is used as the reference solution for auto-zeroing the UV-Vis spectrophotometer if imidazole is used to elute the target protein from the spin columns.

ELUTION (Total spin times = 2 mins)

6. Elute the bound His-tagged protein with 0.65 ml elution buffer pH 7.4 (300 mM imidazole) directly into a fresh centrifuge tube by centrifuging the spin columns for 1 min at 1,800 g. The eluate should be collected for further analysis. Repeat the above elution procedure faithfully to ensure complete recovery of all recombinant proteins.

N.B. Check the protein content of each eluted fraction before pooling them. Otherwise, you risk diluting a concentrated, purified sample.

Pure Protein

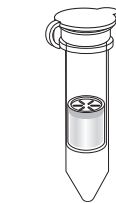

Used Spin Column

DESALTING AND CONCENTRATING

7. Imidazole and any residual metal ions should be removed by diafiltration using ultrafiltration concentrators or rapid dialysis against an appropriate buffer for your downstream application. Otherwise, the imidazole may strip the metal ion from a metalloprotein of interest or the target protein may irreversibly precipitate out of solution when stored at -20°C or -80°C .

REGENERATION OF THE IMAC MINI PLUG

8. Wash the Mini plugs twice with 0.65 ml elution buffer by centrifuging the spin columns at 1,800 g for 1 min. Then wash the plugs twice with 0.65 ml binding buffer by centrifuging the spin columns at 1,800 g for 1 min. Proceed to the pre-equilibration step of another bind-wash-elute cycle if the plugs are to be re-used immediately. After regeneration, plugs can also be stored, without their end caps, in 0.1 % sodium azide (made up in distilled water) at $2-8^{\circ}\text{C}$ until further use.

Easy to read Mini Purification Protocol:

Fraction	Volume	Step	RCF	Spin time
Pre-equilibration #1	0.65 ml	Binding buffer	1,800 g	1 min
Pre-equilibration #2	0.65 ml	Binding buffer	1,800 g	1 min
Sample load	0.65 ml	0.2 μ m filtered sample	640 g	6 min
Wash #1	0.65 ml	Wash buffer	1,800 g	1 min
Wash #2	0.65 ml	Wash buffer	1,800 g	1 min
Wash #3	0.65 ml	Wash buffer	1,800 g	1 min
Wash #4	0.65 ml	Wash buffer	1,800 g	1 min
Wash #5	0.65 ml	Wash buffer	1,800 g	1 min
Final eluate #1	0.65 ml	Elution buffer	1,800 g	1 min
Final eluate #2	0.65 ml	Elution buffer	1,800 g	1 min

Easy to read Mini Regeneration Protocol:

Fraction	Volume	Step	RCF	Spin time
Clean-up #1	0.65 ml	Elution buffer	1,800 g	1 min
Clean-up #2	0.65 ml	Elution buffer	1,800 g	1 min
Wash #1	0.65 ml	Binding buffer	1,800 g	1 min
Wash #2	0.65 ml	Binding buffer	1,800 g	1 min



MINI

I MAC

Step by step protocol for Midi Spin Columns

RESIN PLUG LOADING

1. Load the pre-packed resin Midi plug containing immobilized IMAC resin into the Proteus spin column barrel using the Midi insertion tool as shown on page 15.

PRE-EQUILIBRATION (Total spin time = 3 mins)

2. Equilibrate the IMAC spin column with 10 ml binding buffer, pH 7.4 (10 mM imidazole) by centrifuging the spin column at 500 g for 3 min.

CLARIFICATION OF SAMPLE

3. Filter 22-25 ml sample first through a 1.2 μm pore size syringe filter and then immediately afterwards through a 0.2 μm pore size syringe filter to remove any cellular debris, precipitating protein complexes just prior to sample loading.

SAMPLE LOADING (Total spin time = 30 mins)

4. Pipette up to 20 ml filtered cleared lysate into the spin column and centrifuge the spin column at 100-150 g for 30 min. It may be necessary to increase the spin speed or spin time if any sample remains above the plug.

N.B. In some circumstances, you may wish to re-apply the sample wash back through the spin column before the wash step in order to increase the residence time between the target protein and the resin plug for efficient binding.

* If 1 spin column is to be used, ensure that the spin column is counterbalanced in the centrifuge with a 50 ml centrifuge tube filled with the correct level of water.

WASHING (Total spin time = 9 mins)

5. Wash the spin columns up to three times with 10 ml wash buffer pH 7.4 (30 mM imidazole) to remove non-tagged proteins with no affinity for the immobilized metal ion by centrifuging the spin columns for 3 min at 500 g. The washes should be collected for analysis. As imidazole absorbs UV radiation at 280 nm, we recommend that the wash buffer is used as the reference solution for auto-zeroing the UV-Vis spectrophotometer if imidazole is used to elute the target protein from the spin columns.

ELUTION (Total spin times = 6 mins)

6. Elute the bound His-tagged protein with 10 ml elution buffer pH 7.4 (300 mM imidazole) directly into a fresh centrifuge tube by centrifuging the spin columns for 3 min at 500 g. The eluate should be collected for further analysis. Repeat the above elution procedure faithfully to ensure complete recovery of all recombinant proteins.

N.B. Check the protein content of each eluted fraction before pooling them. Otherwise, you risk diluting a concentrated, purified sample.

Pure Protein



DESALTING AND CONCENTRATING

7. Imidazole and any residual metal ions should be removed by diafiltration using ultrafiltration concentrators or rapid dialysis against an appropriate buffer for your downstream application. Otherwise, the imidazole may strip the metal ion from a metalloprotein of interest or the target protein may irreversibly precipitate out of solution when stored at -20°C or -80°C .

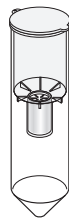

Used Spin Column

REGENERATION OF THE IMAC MIDI PLUG

8. Wash the Midi plugs with 10 ml elution buffer by centrifuging the spin columns at 500 g for 3 min. Then wash the plugs with 10 ml binding buffer by centrifuging the spin columns at 500 g for 3 min. Proceed to the pre-equilibration step of another bind-wash-elute cycle if the plugs are to be re-used immediately. After regeneration, plugs can also be stored, without their end caps, in 0.1 % sodium azide (made up in distilled water) at $2-8^{\circ}\text{C}$ until further use.

Easy to read Midi Purification Protocol:

Fraction	Volume	Step	RCF	Spin time
Pre-equilibration	10 ml	Binding buffer	500 g	3 min
Sample load	Up to 20 ml	0.2 μ m filtered sample	100-150 g	30 min
Wash #1	10 ml	Wash buffer	500 g	3 min
Wash #2	10 ml	Wash buffer	500 g	3 min
Wash #3	10 ml	Wash buffer	500 g	3 min
Final Eluate #1	10 ml	Elution buffer	500 g	3 min
Final Eluate #2	10 ml	Elution buffer	500 g	3 min

Easy to read Midi Regeneration Protocol:

Fraction	Volume	Step	RCF	Spin time
Clean-up	10 ml	Elution buffer	500 g	3 min
Wash	10 ml	Binding buffer	500 g	3 min

Selected applications of IMAC purification of recombinant proteins from crude *E.coli* extract:

A. Multiple-parallel purification of mutant forms of a 6 x His-tagged protein using Proteus IMAC spin columns.

Protocol:

4 g *E. coli* cell pellet were resuspended in 20 ml buffer A and the cells were lysed by sonication before spinning at 40,000 x g. The Proteus spin column was equilibrated in 10 ml Buffer A. Supernatant (2 x 10 ml) was loaded onto the column in a 5 min spin step. The flow-through was passed back over the column to ensure efficient binding. The column was then washed with 2 x 10 ml wash buffer B, before eluting with 2 x 10 ml elution buffer C.

The flow-through and eluted fractions were then run on an SDS-polyacrylamide gel (Fig A1). The above protocol was applied to the wild-type protein and six site-specific mutants in parallel (Fig A2), yielding >95% pure protein.

Binding Buffer A: 50 mM sodium phosphate, 0.3 M NaCl, 5 mM β -mercaptoethanol pH 8.0.

Wash Buffer B: 50 mM sodium phosphate, 0.3 M NaCl, 50 mM imidazole, 5 mM β -mercaptoethanol pH 8.0.

Elution Buffer C: 50 mM sodium phosphate, 0.3 M NaCl, 250 mM imidazole, 5 mM β -mercaptoethanol pH 8.0.

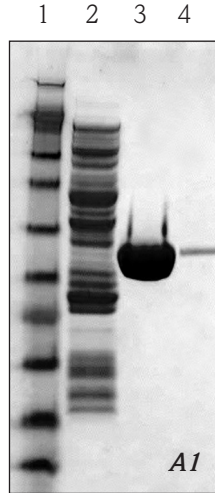

Fig A1: Lane 1 corresponds to molecular weight markers. Lane 2 corresponds to flow through. Lanes 3 & 4 correspond to the 1st and 2nd final eluate.

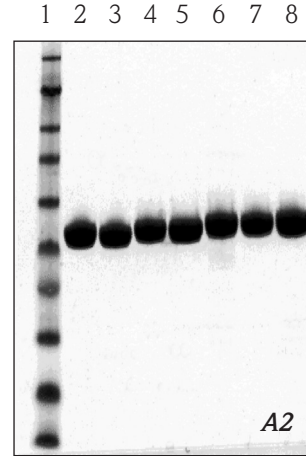

Fig A2: Lane 1 corresponds to molecular weight markers. Lane 2 corresponds to final eluate of the wild type protein. Lanes 3 - 8 correspond to final eluates of 6 mutant His-tagged proteins.

B. Purification of C-terminal His-tagged protein using Proteus IMAC Midi spin columns under native conditions.

E. coli cell pellets were lysed by sonication in Buffer A, pH 7.4 and clarified by centrifugation and subsequent filtration. 10 ml sample was loaded on to the buffer A-pre-equilibrated Proteus IMAC column and spun at 150 g for 30 min. The column was washed with 3 x 10 ml wash buffer B and the target protein was eluted twice with 4 ml elution buffer C. The bind-wash-elute cycle was repeated with a further 10 ml sample to ensure that the performance of the column was unaffected in the second bind-wash-elute cycle when there was no further charging of the column with Ni metal.

The binding capacity of the Proteus IMAC column was unaffected after two consecutive purification runs. The recovered capacity of the column was 18 mg recombinant protein after the first purification cycle and 20 mg recombinant protein after the second purification cycle. This exceeded the stated 10 mg capacity of the column.

SDS-PAGE confirms the excellent purity of the target protein (see Fig. B).

Binding Buffer A: PBS buffer pH 7.4.

Wash Buffer B: PBS buffer pH 7.4, 1 M NaCl, 20 mM imidazole.

Elution Buffer C: PBS buffer pH 7.4, 300 mM imidazole.

Fig. B

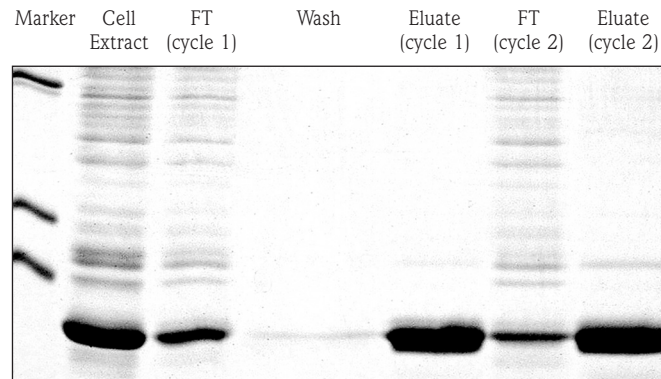

C. Purification of a His-tagged protein under denaturing conditions using the Proteus IMAC Mini spin columns

Filtered cell extract was equilibrated with 2x 0.65 ml buffer A by centrifuging the spin column at 1,800 g for 1 min. Sample (0.65 ml) was spun through the spin column at 640 g for 6 min. The spin columns were washed 5 times with 0.65 ml wash buffer B and the bound recombinant protein was eluted twice with 2 x 0.65 ml elution buffer C by centrifuging the spin column at 1,800 g for 1 min. Nearly all of the recombinant protein was eluted in the elution step with elution buffer C. Excellent purity was observed in the SDS-polyacrylamide gel (Fig. C). A total of 0.55 mg recombinant protein was recovered from the final eluate.

Binding Buffer A: 0.1 M sodium phosphate, 10 mM Tris, 10mM imidazole, 8 M Urea pH 8.0

Wash Buffer B: 0.1 M sodium phosphate, 10 mM Tris, 20 mM imidazole, 8 M Urea pH 8.0

Elution Buffer C: 0.1 M sodium phosphate, 10 mM Tris, 250 mM imidazole, 8 M Urea pH 8.0

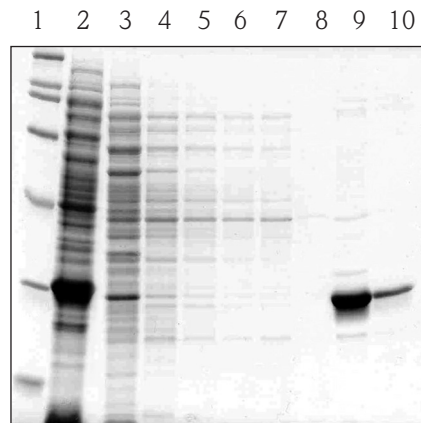

Fig C: SDS-polyacrylamide gel (12.5 %) showing the purity of the His-tagged recombinant protein. Lane 1 corresponds to the molecular weight markers; Lane 2 corresponds to the sample load; Lane 3 corresponds to the flow through; Lanes 4-8 correspond to the wash steps and Lanes 9 & 10 correspond to the 1st and 2nd final eluates.

D. Purification and multiple loading of a membrane-associated His-tagged protein under native conditions using the Proteus MC Midi spin columns

7 g *E. coli* cell pellet was re-suspended in 60 ml lysis buffer pH 8.0 (+ 0.01 % Triton X-100) and lysed by sonication. The suspension was filtered through a 0.2 μm filter and loaded on to the pre-equilibrated spin column in 3 x 20 ml aliquots. The spin column was washed with 3 x 10 ml wash buffer B and the target protein was eluted with 10 ml elution buffer. The sample flow through, washes and eluate were run on a 10 % SDS-polyacrylamide gel prior to Western blotting. The Western blot (Fig. D) showed no trace of the 50 kDa target protein in the flow through or wash steps, demonstrating an extremely high binding efficiency of the His-tagged target protein to the Proteus metal chelate column.

Binding Buffer A: 50 mM sodium phosphate, 0.3 M NaCl, 10mM imidazole, 0.01 % Triton X-100 pH 8.0

Wash Buffer B: 50 mM sodium phosphate, 0.3 M NaCl, 30mM imidazole, 0.01 % Triton X-100 pH 8.0

Elution Buffer C: 50 mM sodium phosphate, 0.3 M NaCl, 300mM imidazole, 0.01 % Triton X-100 pH 8.0

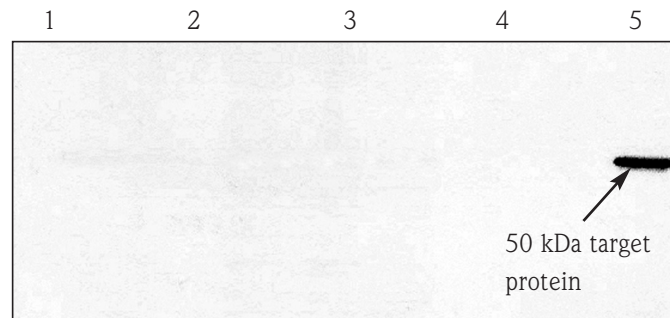
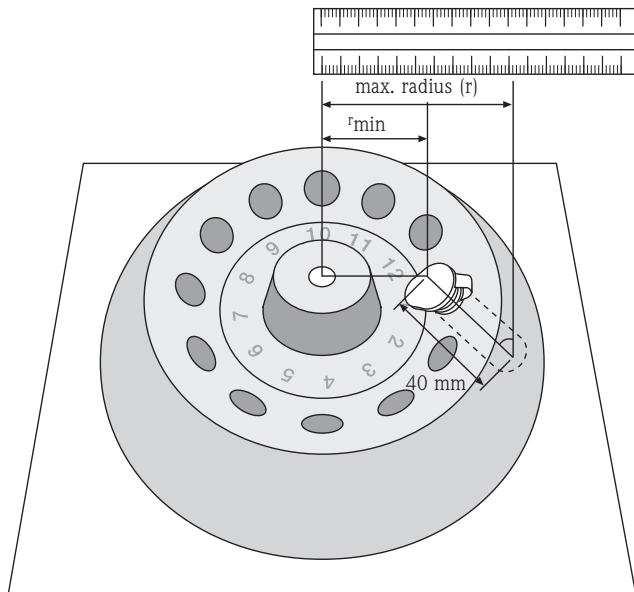

Fig D: Western blot showing the purity of the membrane-associated His-tagged recombinant protein in lane 5 and the absence of target protein in the flow through and washes (lanes 1-4). Lane 1 responds to the flow through; Lanes 2-4 correspond to the wash steps and Lane 5 corresponds to the final eluate.



Take radius measurement in mm from center of rotor to center of microcentrifuge tube lid. Value = r_{min} .



How to convert rpm to g force (RCF) using a 45° fixed angle rotor

It is important that the Proteus spin columns are centrifuged at the correct speeds. Use of considerable higher speeds than those indicated may damage the resin matrix and result in reduced performance. Many centrifuges display only rpm. See the diagram to enable accurate conversion between rpm and RCF (g force). This formula will work on any rotor providing an accurate measurement is taken from the center of the rotor to the centre of the microfuge tube lid.

$$RCF = 1.12 \times r \left(\frac{rpm}{1000} \right)^2$$

Where r = maximum radius, RCF = g force, RPM = revs per min. E.g. A 12 holder Sanyo Micro Centaur has an R_{max} of 63.2 mm when 2.2 ml microcentrifuge tubes are used. Therefore 3,000 rpm corresponds to 637 g and 5,000 rpm corresponds to 1,770 g.

Determination of the maximum radius (r)

r = minimum radius in mm (r_{min}) + 40 mm (the length of the micro-centrifuge tube). $\sin 45^\circ$

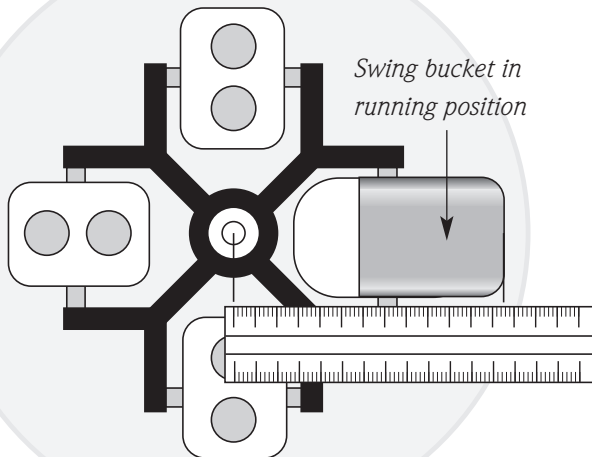

Take radius measurement in mm from center of rotor to bottom of bucket. Value = r.

How to convert rpm to g force (RCF) for the MIDI spin column using a swing bucket rotor

It is important that the Proteus spin columns are centrifuged at the correct speeds. Use of higher speeds than those indicated may damage the resin matrix and result in reduced performance. Many centrifuges display only rpm. See the diagram to enable accurate conversion between rpm and RCF (g force). This formula will work on any rotor providing an accurate measurement is taken from the center of the rotor to the bottom of the swing bucket at its open position (when the bucket is rotated through 90° in its running position).

$$\text{RCF} = 1.12 \times r \left(\frac{\text{rpm}}{1000} \right)^2$$

Eg. 500 g corresponds to 1670 rpm when the radius (r) = 160 mm

Metal Chelate kit buffer formulations:

Under denaturing conditions, you may choose to add urea to the buffers below. In this case, 480.48 g urea (M_r 60.06) should be added to a final 1 L buffer volume. Also note that the final pH of the buffers containing urea only should be adjusted immediately before use. All buffers contain 0.1 % sodium azide as preservative.

5 x PBS buffer: *To prepare 1 L 5 x binding buffer: Add 4.2103 g NaH_2PO_4 (M_r 137.99, monohydrate), 58.8455 g Na_2HPO_4 (M_r 268.1, heptahydrate), 87.66 g NaCl (M_r 58.44), 1.0 g NaN_3 to 800 ml distilled water. Make up volume to 1L with distilled water. Do not adjust the pH at 5x. The pH of the concentrated stock solution will be lower than that of the diluted form.*

1 x Imidazole buffer: *To prepare 1 L 1 x binding buffer: Add 5.52 g NaH_2PO_4 (M_r 137.99, monohydrate), 2.681 g Na_2HPO_4 (M_r 268.1, heptahydrate), 17.532 g NaCl (M_r 58.44), 1.0 g NaN_3 , 68.08 g imidazole (M_r 68.08) to 750 ml distilled water. Use 6 N hydrochloric acid to adjust the pH to 7.4 at 25°C. Make up volume to 1L with distilled water.*

Questions and Answers:

1. What is the shelf-life of a Proteus spin column?

The spin columns and resin plugs are guaranteed for 2 years after the date of manufacture provided they are stored at 2-8°C.

2. What is the preferred rotor for the Proteus Mini and Midi spin columns?

Mini spin columns: The preferred rotor is a fixed angle rotor. There is no need to orientate the Mini spin column in the fixed angle rotor. **Midi spin columns:** The preferred rotor is a swing bucket rotor. For optimal performance with a fixed angle rotor, ensure that the orientation of the spin column in the rotor is the same for sample binding, washing and elution steps.

3. Do I need to filter the buffers prepared in my laboratory?

It is good laboratory practice to filter all buffers. However, buffers supplied with the kit are pre-filtered for immediate use.

4. Do I need to pre-filter my sample before loading it on to a Proteus spin column?

All samples should be filtered through a final 0.2 µm syringe filter just before the sample loading step.

5. What are the binding capacities of Proteus Mini and Midi IMAC spin columns?

Mini spin columns: Protein IMAC resin plugs have typical capacities of 1 mg His-tagged protein. **Midi spin columns:** Protein IMAC resin plugs have typical capacities of 10 mg His-tagged protein.

6. How should I prepare my sample for the Proteus spin column?

Many chromatographic procedures demand that the sample is pre-conditioned prior to loading. We recommend that all samples are pre-filtered down to a 0.2 µm pore size. High viscosity is mostly attributed to contaminating DNA or RNA. The intrinsic viscosity of a lysate can be reduced by either drawing it through a syringe needle several times or by adding appropriate amounts of DNase and/or RNase (5-10 µg/ml) to the lysis buffer and incubating the mix on ice for 15 mins.

7. Should I add β -mercaptoethanol to the lysis buffer?

Reducing agents can reduce the resin matrix and adversely affect binding of the His-tagged protein to the spin column. Its inclusion depends upon whether the His-tagged protein elutes with contaminants as β -mercaptoethanol can reduce all disulphide bonds formed between the contaminating proteins and the target protein. Concentration less than or equal to 10 mM β -mercaptoethanol can be used with Proteus IMAC resin spin columns. Do not use strong reducing agents such as DTT or DTE as these tend to reduce the metal ion, which will lower the binding efficiency of the IMAC column.

8. What is the maximum volume of solution I can load on to a Mini or Midi spin column?

Mini spin columns: You can load a maximum volume of 0.65 ml. **Midi spin columns:** You can load up to 20 ml in a swing bucket rotor and up to 10 ml in a fixed angle rotor. Multiple 0.65 ml or 20 ml loads can be performed with low expression systems.

9. What is the highest speed that I should spin the Proteus Mini and Midi spin columns?

Mini spin columns: Although the spin columns have been tested at 11,960 g (13,000 rpm in a fixed angle rotor with an average radius of 49 mm), we do not recommend spin speeds greater than 5,000 g. At very high speed, you may observe gel shrinkage away from the side walls. This will not affect the performance of the spin columns as the gel will rehydrate rapidly in subsequent spin steps. **Midi spin columns:** There is no need to spin the devices at speeds greater than 1,000 g. No performance data is available at centrifugal speeds greater than 1,250 g.

10. Is there a minimum spin speed for the Mini and Midi spin columns?

There are no minimum speeds for either the Mini or Midi spin columns. The devices can be spun at speeds as low as 50 g.

11. Why are the sample loading steps for the Mini and Midi spin columns extended to 6 min and 30 min respectively?

The metal chelate resin plug incorporates a technologically-advanced flow regulator which is designed to control the flow rate of the samples through the active column matrix.

Observed yields and purities fluctuate as a direct function of the flow rate of the sample loading step. The flow regulator is pre-set by Pro-Chem to slow down the flow rate to an optimal capture speed. The concomitant increase in the residence time of the target protein with the matrix of the spin column increases substantially the yield and purity of the purified target protein. However, unlike many other chromatography systems, there are negligible hold-up volumes and His-tagged protein elution to recover the purified target protein is rapid for both Mini (1 min) and Midi (3 min) columns.

12. What are the minimum elution volumes from the Proteus spin columns?

Mini spin columns: The minimum elution volume is 0.5 ml.

Midi spin columns: The minimum elution volume is 4 ml.

13. How can I regenerate the Proteus IMAC plugs?

Mini spin columns: We recommend that you wash the plugs with 2 x 0.65 ml elution buffer by centrifuging the spin columns at 1,800 g for 1 min. Then re-equilibrate the plugs with 2 x 0.65 ml binding buffer by centrifuging the spin columns at 1,800 g for 1 min. Proceed to the pre-equilibration step if plugs are to be re-used immediately.

After regeneration, plugs can also be stored, without their end caps, in a screw-capped Falcon tube containing 0.1 % sodium azide (made up in distilled water) at 2-8 °C until further use. **Midi spin columns:** We recommend that you wash the plugs with 10 ml elution buffer by centrifuging the spin columns at 500 g for 3 min. Then re-equilibrate the plugs with 10 ml binding buffer by centrifuging the spin columns at 500 g for 3 min. Proceed to the pre-equilibration step if plugs are to be re-used immediately. After regeneration, plugs can also be stored, without their end caps, in a screw-capped Falcon tube containing 0.1 % sodium azide (made up in distilled water) at 2-8 °C, until further use.

14. Can I autoclave the Proteus IMAC plugs?

The Proteus IMAC plugs cannot be autoclaved.

15. Can I immobilize the metal chelate resin with a different metal ion?

Ensure that the resin is stripped of Ni^{2+} . This is achieved by successive washing with 10 column volumes of (i) 0.2 M EDTA, 0.5 M NaCl (ii) 0.2 M NaOH (iii) distilled water and finally (iv) 0.1 M metal salt.

16. What can I do if the resin has changed colour?

The blue colour is attributed to the Ni^{2+} salt. Reductants will cause the resin to turn brown and chelating agents will cause the resin to turn white. Ensure that all solutions are compatible with the Ni-IDA resin.

17. How can I re-charge the plug with NiSO_4 ?

Wash the Midi plugs with 20 ml distilled water followed by 20 ml washes with 0.1 M NiSO_4 solution (made up in distilled water). Wash off any unbound NiSO_4 with 20 ml distilled water and equilibrate the plug with 20 ml 1 x PBS

buffer, pH 7.4. Spin the Midi plug at 500 g for 3 min for all above steps. Use appropriate buffer volumes for re-charging Mini plugs and spin the Mini plug at 1,800 g for 1 min.

18. How can I ensure that levels of contaminants in the final eluate remain low?

We recommend that the binding buffer contains minimum 10 mM imidazole and the wash buffer contains minimum 20-30 mM imidazole.

19. Should I be concerned if the plugs partially dry out during the centrifugal steps?

The plugs are robust. Partially dried plug rehydrate rapidly. There are no adverse effects upon the performance of the plugs.

20. Should I remove imidazole after the final elution step?

You should always remove imidazole if the protein is going to be stored. Otherwise, the protein may precipitate out of solution at -20 or -80 °C.

21. Can I load purified protein immediately on to an SDS-gel?

Proteins purified under native conditions can be loaded on to an SDS-polyacrylamide gel. Those proteins purified under denaturing conditions in 6-8 M urea can also be loaded directly on to a denaturing SDS-polyacrylamide gel. Proteins purified in the presence of 4-6 M guanidine HCl should be buffer exchanged in buffers lacking the denaturant prior to a denaturing SDS-PAGE.

22. Do I need to remove the His-tag from the recombinant protein after purification?

Normally, a protease cleavage site e.g. Factor Xa Protease is engineered between the His-tag and the target protein. The target protein can then be re-purified by passing it through a Proteus Ni²⁺-IDA spin column in order to purify undigested His-tagged protein. For most applications, it is not necessary to remove the His-tag. However, it is often desirable to remove the His-tag if X-ray crystallography or NMR is to be used to determine the structure of the target protein.

23. Under what circumstances should I re-use the spin columns?

The spin columns can be re-used. Re-use does depend on the properties of your target protein. You may observe that flow rates slow down in successive bind-wash-elute cycles as more samples are progressively loaded on to the columns. In addition, if the plug is not re-charged with Ni²⁺, binding capacity may be reduced.

24. How many times can I re-use the Proteus Mini and Midi spin columns?

Mini spin columns: Assuming that all samples are correctly filtered, sufficient buffer is provided in the kit for 2 re-uses of each Mini spin column. **Midi spin columns:** Each Midi plug can be re-used typically 2 times without the need for Ni²⁺ re-charging. There is sufficient buffer volume in the kit for 1 complete use of each Midi spin column.



Troubleshooting assistant:*Bubbles or cracks appear in the resin bed*

- The spin column has been stored at a cool temperature and then rapidly warmed up. Proteus spin columns should be warmed slowly to room temperature before use.

The sample does not flow easily through the spin column

- The centrifugal speed for the sample loading step can be increased to 1,250 g.
- The resin is clogged with particulates. Pre-filter the sample just before loading it on to the Proteus spin column.
- If the spin columns are not stored at 2-8 °C, or they have been used more than once and stored in the absence of a bacteriostat, microbial growth in the column may restrict flow through the resin plug.

No elution of the target protein is observed from the spin column

- The elution conditions are too mild to desorb the target protein. Use a higher concentration of imidazole or lower the elution pH further!
- Ensure that the resin is blue in appearance. Otherwise the expressed protein will not bind effectively to the spin column.
- Ensure that there are no chelators or reductants in the sample which will interfere with binding of the target protein to the spin column.
- The protein may have precipitated in the column. Use denaturing conditions!
- The cell disruption method may have liberated proteolytic activities. Purify the protein under denaturing conditions if you do not need to purify an active protein.

The recovery of target protein is low

- The His-tag may be inaccessible. Either move the affinity tag to the other end of the protein or perform the purification under denaturing conditions.
- Ensure that the resin bed volume is proportionate to the level of expressed His-tagged protein. The target protein may pass through into the sample wash if the capacity of the resin plug is insufficient for the level of expressed protein.
- Confirm levels of target protein by immunoassay. This will help determine if your cell disruption methods have been successful.
- The target protein may contain hydrophobic stretches which could have been toxic to the host bacterium, *E.coli*.
- Ensure that the protein is not insoluble i.e. exists in inclusion bodies and resides in the pellet. Solubilize the insoluble protein using 6-8 M urea or 4-6 M guanidine hydrochloride.

- Add further protease inhibitors to the buffers as the full-length protein may have been degraded by hydrolytic enzymes. Alternatively, reduce the time of expression, lower the temperature at which the protein is exposed or use special *E.coli* strains devoid of proteases.

Poor resolution of the target protein

- The sample volume or concentration may be too large for the capacity of the resin plug. In this case, reduce the sample load or sample volume.
- The sample may also need to be filtered carefully.

The target protein elutes at an unexpected position

- There may be an ionic interaction between the protein and Proteus resin. You should maintain the ionic strength above 0.1 M.
- There may be hydrophobic interactions between the sample and Proteus resin. In this instance, reduce the salt concentration and add suitable detergents or organic solvents.
- Co-purification of contaminants may occur if both the

expressed protein and the contaminant have similar affinities for the matrix. In this case, a further chromatographic method such as gel filtration or ion exchange chromatography is recommended.

The elution profile cannot be reproduced

- The nature of the sample may have altered and so it may be important to prepare a fresh sample. The His-tag may have been removed by proteases. Work at 2-8 °C and add a protease inhibitor cocktail to the lysis buffer.
- Accessibility of the His-tag may have altered. If the His-tag becomes buried in the protein, the binding capacity of any metal chelate resin for this target protein will be significantly reduced under native conditions. In this instance, the purification needs to be performed under denaturing conditions.
- The sample load may be different from the original sample load. It is advisable to keep all these parameters constant.
- Proteins or lipids may have precipitated in the resin bed.

Use elution conditions, which stabilize the sample.

- The buffer pH and ionic strength are incorrect and new buffers will need to be prepared.

Glossary:

affinity chromatography - chromatographic separation based on a specific interaction between an immobilized ligand and a binding site on a macromolecule.

baculovirus – a virus vector for expression of recombinant proteins in insect cells.

bed volume - the total volume occupied by the chromatographic packed bed. It is also referred to as the column volume or CV.

chaotropic agent - a molecule which interferes with hydrophobic interactions by disrupting the ordered structure of water molecules. Examples include urea and guanidine.

chelating agent – a compound such as EDTA or EGTA that is able to combine with a metal ion to form a structure with one or more rings.

cleared lysate – the soluble cell extract after the cell debris and other particulates have been removed by centrifugation.

expression vector – a cloning vector intended for the foreign gene to be expressed in the host organism.

french pressure cell – a device that uses high shear forces to rupture microbial cells. The suspension is poured into a chamber, which is closed at one end by a needle valve and at the other end by a piston. Pressures of up to 16,000 lb/in² are applied by a hydraulic press against a closed needle valve. When the desired pressure is attained, the needle valve is fractionally opened to marginally relieve the pressure. The cells subsequently expand and rupture, thereby releasing the cellular components through the fractionally open valve.



freeze-thawing – a method that is sometimes used to break open cells by successive periods of slow freezing and thawing. Ice crystals are generated during the freezing stage, which disrupt the cells when they melt during thawing. The method, however, is slow and releases a limited amount of subcellular components.

his - a 3 letter symbol for L-histidine

his-tag – a permanent affinity tag engineered into the expression vector upstream or downstream of the gene of interest to facilitate the purification of the recombinant protein. The His-tag doesn't normally have any effect upon the protein structure or function, it comprises 6 x Histidine residues (Hexahistidine) and has a molecular weight of 0.7-0.9 kDa

immobilized - bound to a surface, usually through covalent linkages.

inclusion bodies – quite a lot of proteins form insoluble crystalline aggregates known as inclusion bodies when they are expressed at high levels inside bacteria. The proteins can be solubilized using denaturants such as 8 M urea or 6 M guanidine hydrochloride.

ion exchange chromatography - chromatographic separation based on different charge properties of macromolecules.

isoelectric point - the pH at which the protein has no net charge.

lysozyme – an enzyme that hydrolyzes β -1,4-linkages between N-acetylmuramic acid and 2-acetamido-2-deoxy-D-glucone in peptidoglycan heteropolymers of prokaryotic cell walls. An example is egg white lysozyme and this enzyme is used to disrupt cells in order to liberate expressed proteins. 1 mg/ml lysozyme is normally added to *E.coli* cells in lysis buffer and incubated for 30 min to aid cell disruption. The pH optimum for lysozyme is pH 9.2 (Davies et al 1969).



metal chelate affinity chromatography – a form of affinity chromatography where a suitable chelator such as iminodiacetic acid is cross-linked via long stable hydrophilic spacer arm to a matrix such as agarose. The resin is then saturated with an appropriate metal ion, which then has a high affinity for peptidic metal chelates such as poly His-tags.

recombinant protein – a protein coded for by a cloned gene which has often been modified to increase the expression of that protein or to alter the properties of the protein.

sonication – this technique uses ultrasonic energy to generate high transient pressures that are believed to disrupt the cells.

truncate - terminate prematurely or to shorten by cutting.

References:**Affinity Separations: A Practical Approach**

1997 (Matejtschuk, P Ed.) IRL PRESS at Oxford University Press. ISBN: 0-19-963550-1.

Biochemistry, 2nd Edition

1996 (Mathews, CK & van Holde, KE) Benjamin/Cummings Publ. Co. ISBN: 0-8053-3931-0.

Insect cell culture technology in baculovirus expression systems Cameron, I. R et al (1989). Trends in Biotechnology, 7, 66-70.

Cuatrecasas, P, Wilcheck, M. and Anfinsen, C.B. (1968) Proc. Natl. Acad. Sci. U.S.A. 61, 636.

Davies, A., Neuberger, A. and Wilson, B. (1969). Biochim. Biophys. Acta 178, 294.

Protein Purification Applications: A Practical Approach

1995 (E.L.V. Harris and S. Angal Eds.) IRL PRESS at Oxford University Press. ISBN: 0-19-963023-2.

Recombinant Protein Protocols

1997 (RS Tuan Ed.) Humana Press, ISBN: 0-89603-400-3.

Metal Chelate Affinity Chromatography: A New Approach to Protein Fractionation, Nature (1975) 258, 598. Porath, J., Carlson, J., Olsson, I., and Belfrage, G.

Porath, J. and Olin, B. (1983) Biochemistry 22, 1621

Porath, J. (1988) Trends Anal. Chem. 7, 254.

Immobilized metal ion affinity chromatography

Porath, J. (1992).

Protein Expression and Purification 3, 263-281.

Sulkowski, E. (1989) BioEssays, 10, 170.

Ordering Information:

Mini Products	Quantity	Order codes
Mini IMAC Starter Kit (8 units)	1	PC-MMCK-08
Mini IMAC Kit (24 units)	1	PC-MMCK-24
Mini IMAC Pack (24 units; excludes UF concentrators)	1	PC-MMCC-24
Mini IMAC Bulk Pack (72 units; excludes UF concentrators and buffers)	1	PC-MMCC-72
Midi Products	Quantity	Order codes
Midi IMAC Kit (8 units)	1	PC-MCK-08
Midi IMAC Pack (8 units; excludes UF concentrators)	1	PC-MCC-08
Midi IMAC Bulk Pack (24 units; excludes UF concentrators and buffers)	1	PC-MCC-24
Accessories	Quantity	Order codes
IMAC Buffer Pack (250 ml 5 x PBS Buffer A, 150 ml 1 x Imidazole Buffer B)	1	PC-BMCP



PROTEUS



Protein Ark Ltd, The Innovation Centre, 217 Portobello, Sheffield S1 4DP, UK

Tel: +44 (0) 33 33 40 20 25

Fax: +44 (0) 33 33 40 20 25

Email: info@proteinark.com

Web: www.proteinark.com

© 2014 Protein Ark Ltd